

SELV

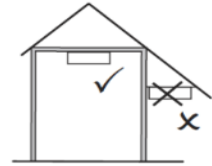

IP20

LED



Hole for mounting

1

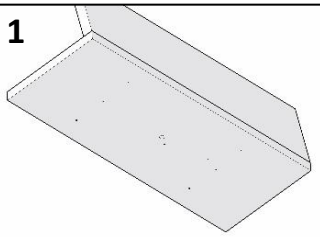

2

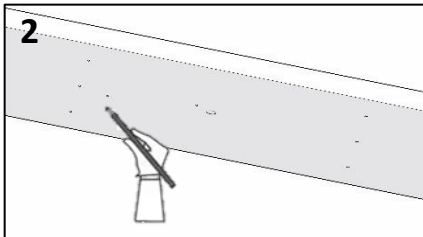

3

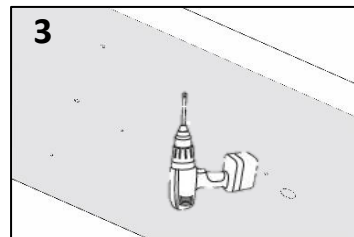

Suspension kit

4

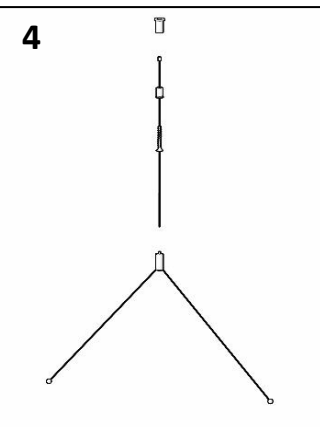

4.1

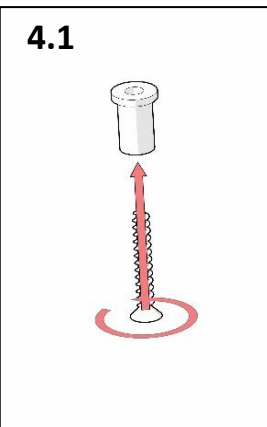

4.2

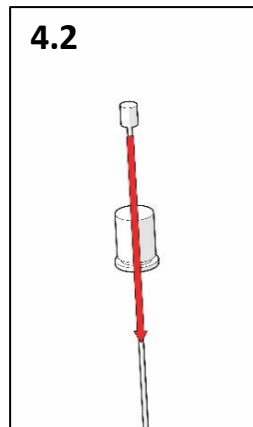

4.3

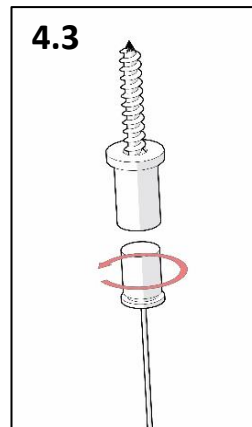

4.5

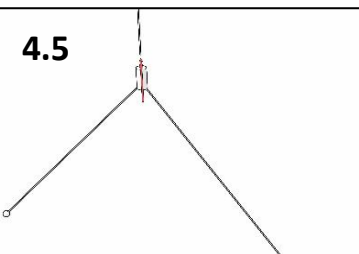

4.6

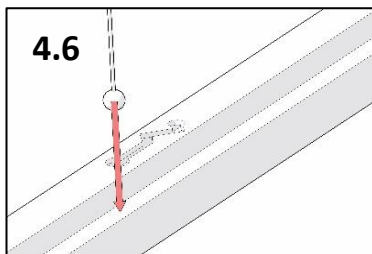

4.7

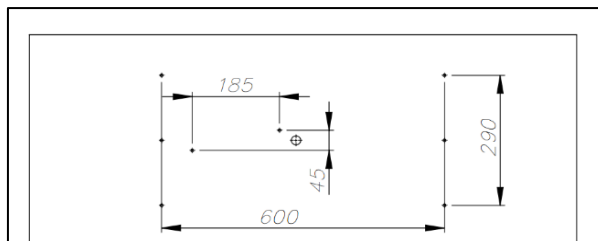
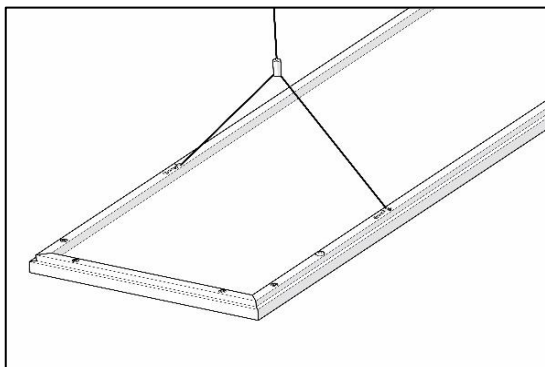
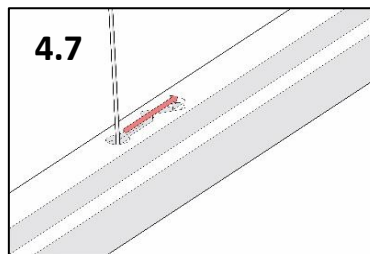

Mounting and connection rosette

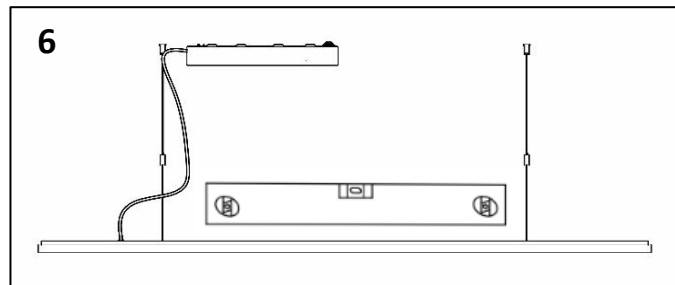
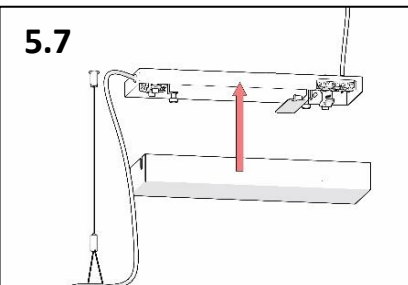
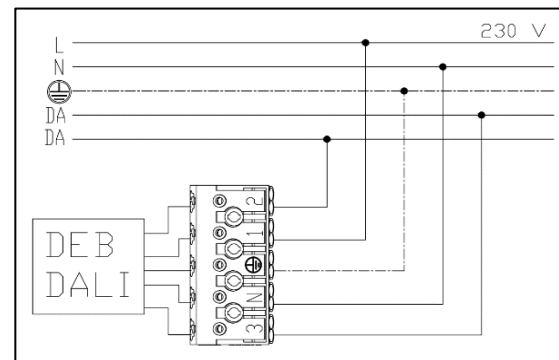
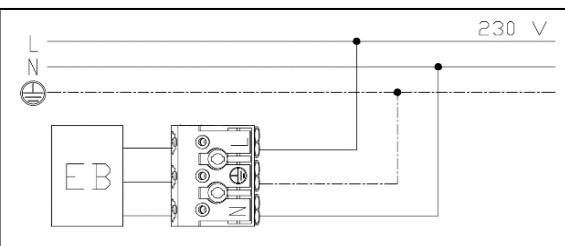
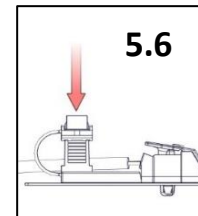
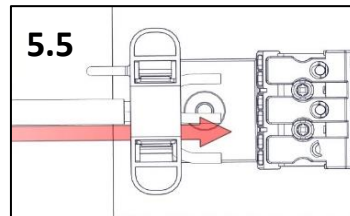
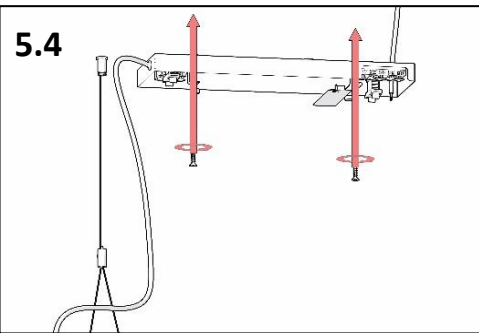
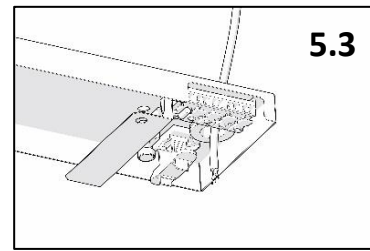
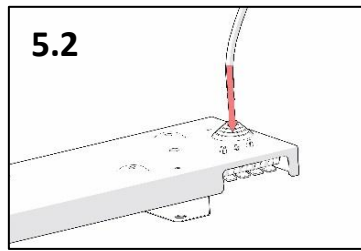
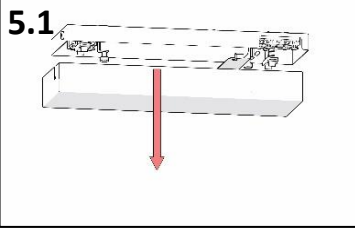

OPTION: Connection LED source

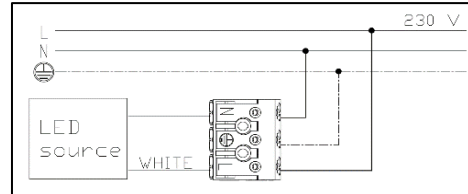
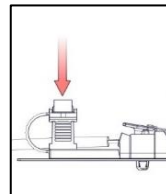
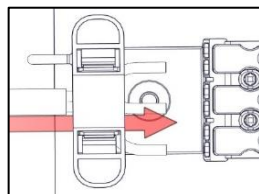
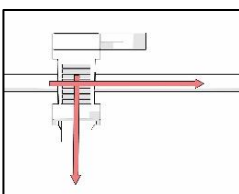

Note

General safety notes:

1. Only competent persons are allowed to perform mounting and maintenance.
2. Before installation make sure that there is no voltage in the network.
3. Use only original parts for repairs or maintenance.
4. Use only fixtures with proper IP protection in wet rooms.
5. Before servicing, it is obligatory to disconnect the fixture from the network voltage.
6. Manufacturer does not guarantee for damage caused by incorrect installation and/or use.
7. Any operation performed on the fixture that is not in accordance with instructions will void manufacturer's warranty.